

# Product Parts Breakdown

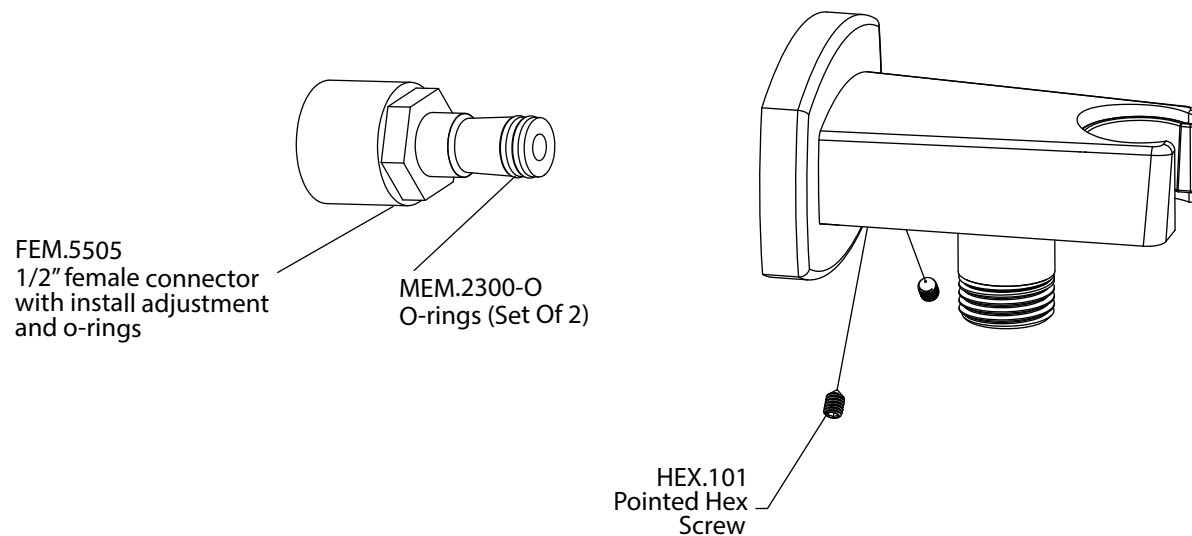

**isenberg**  
innovation+design

240.8006

Ver 2.53